

LED梳妆镜

米亚系列

安装使用说明书

LED Mirror

MIA Series

INSTALLATION INSTRUCTIONS

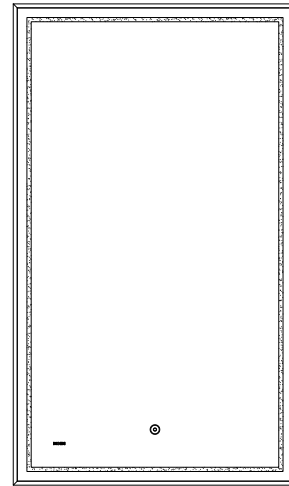

如需安装支持，配件丢失等，请联系MOEN。

(中国) 400-630-8866

www.moen.cn

PLEASE CONTACT MOEN FIRST

For Installation Help, Missing or Replacement
Parts

(China)400-630-8866

www.moen.cn

推荐工具

为了安全和让安装和替换变得容易，Moen建议您使用以下工具：

HELPFUL TOOLS

For safety and ease of replacement, Moen recommends the use of these helpful tools.



图片仅供参考

(款式因型号而异)

Image is for reference only

(Style varies by model)

记录购买的型号：

(保存安装说明书以备将来参考)

Record Purchased Model Number:

(Save instruction sheet for future reference)

安装前注意事项

- 请仔细阅读本说明书，以便熟悉所需工具、物料、安装过程。请按照适用的章节来安装本产品，以免安装失当导致不必要的损失。除了正确的安装方法之外，请详阅所有操作及安全指引。
- 本说明书所载的一切资料，均以印刷时所有之最新产品情况为基础，MOEN保留对产品进行修改、改进的权利，技术参数如有更改，恕不另行通知。
- 在安装MOEN产品之前，请先确认所有必须的电气工作均已完成。并确认遵循制造商相关电动工具的安全的指令。
- 强烈建议在柜体安装前拆门板，使安装过程安全，具体步骤参考后续指导。
- 安装之前，仔细检查产品是否有损伤。
- MOEN产品性能卓越，经久耐用。为保证产品品质，请按照此说明书中推荐的方法进行安装，启用，操作和维护。
- 强烈要求输入电源（输入：220V-240V）必须带有地线及漏电开关。⊕
- 灯板内有高压电设备，非专业人士请勿拆开。⚠
- Y型连接：如果此灯具的外部软缆或软线损坏了，该线要由制造商或其服务代理商或有类似资格的人更换，以避免发生危险。
- 不可替换光源：此灯具的光源是不可替换的；当光源到其寿终时，应替换整个灯具。



警告：有触电的危险。

请找合格的电工来进行所有的线路连接。



警告：有触电的危险。

工作之前先切断电源。

Precautions before Installation

- Please read this manual carefully to familiarize with the required tools, materials, and installation. Please install this product in accordance with the applicable chapters to avoid unnecessary losses. In addition to the installation method, please read all operation and safety guidelines.
- All information contained in this manual is based on all the latest product conditions at the time of printing. MOEN reserves the right to modify and improve the product. Technical parameters are subject to change without notice.
- Before installing products, please confirm that all necessary electrical work has been completed. And follow the manufacturer's safety instructions related to power tools.
- It is strongly recommended to remove the doors before installing the cabinet. Refer to the corresponding instructions for specific steps.
- Before installation, check the product for damage.
- MOEN products are excellent in performance and durable. In order to ensure product quality, please follow the methods recommended in this manual for installation, activation, operation and maintenance.
- The glass laminate can carry up to 5kg articles.
- It is strongly required that the input power supply (input: 220 v-240 V) must be equipped with ground wire and leakage switch. ⊕
- There are high-voltage electrical equipment in the lamp board. Please do not disassemble it for non professionals. ⚠
- Y-type connection: if the external flexible cable or cord of the lamp is damaged, the cord shall be replaced by the manufacturer or its service agent or a person with similar qualifications to avoid danger.
- Non replaceable light source: the light source of this lamp is non replaceable; When the light source reaches its end of life, the entire lamp shall be replaced.



WARNING: Risk of electrical shock.

A licensed electrician should make all electrical connections.



WARNING: Risk of electrical shock.

Disconnect power before servicing.

零件清单 Parts List

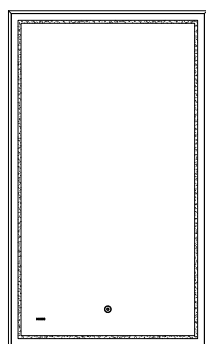

挂镜 1件
Mirror 1pc



镜挂 1件
Hanger 1pc



4.2x45自攻螺丝3颗
4.2x45 lock wall screw 3pcs



上墙胶粒3颗
plastic particles 3pcs

订购信息 Ordering Information

BCM21-001BK 1000×600mm LED梳妆镜（墨黑）	BCM21-001BK 1000×600mm LED Mirror (Ink Black)
BCM21-001WH 1000×600mm LED梳妆镜（极地白）	BCM21-001WH 1000×600mm LED Mirror (Polar White)
BCM21-002BK 530×900mm LED梳妆镜（墨黑）	BCM21-002BK 530×900mm LED Mirror (Ink Black)
BCM21-002WH 530×900mm LED梳妆镜（极地白）	BCM21-002WH 530×900mm LED Mirror (Polar White)

尺寸图 Rough-in Dimension

单位 Unit

产品名称 Product Name	示意图 Diagram
1000×600mm LED梳妆镜 LED Mirror	<p>防雾膜 Anti-fog film</p>

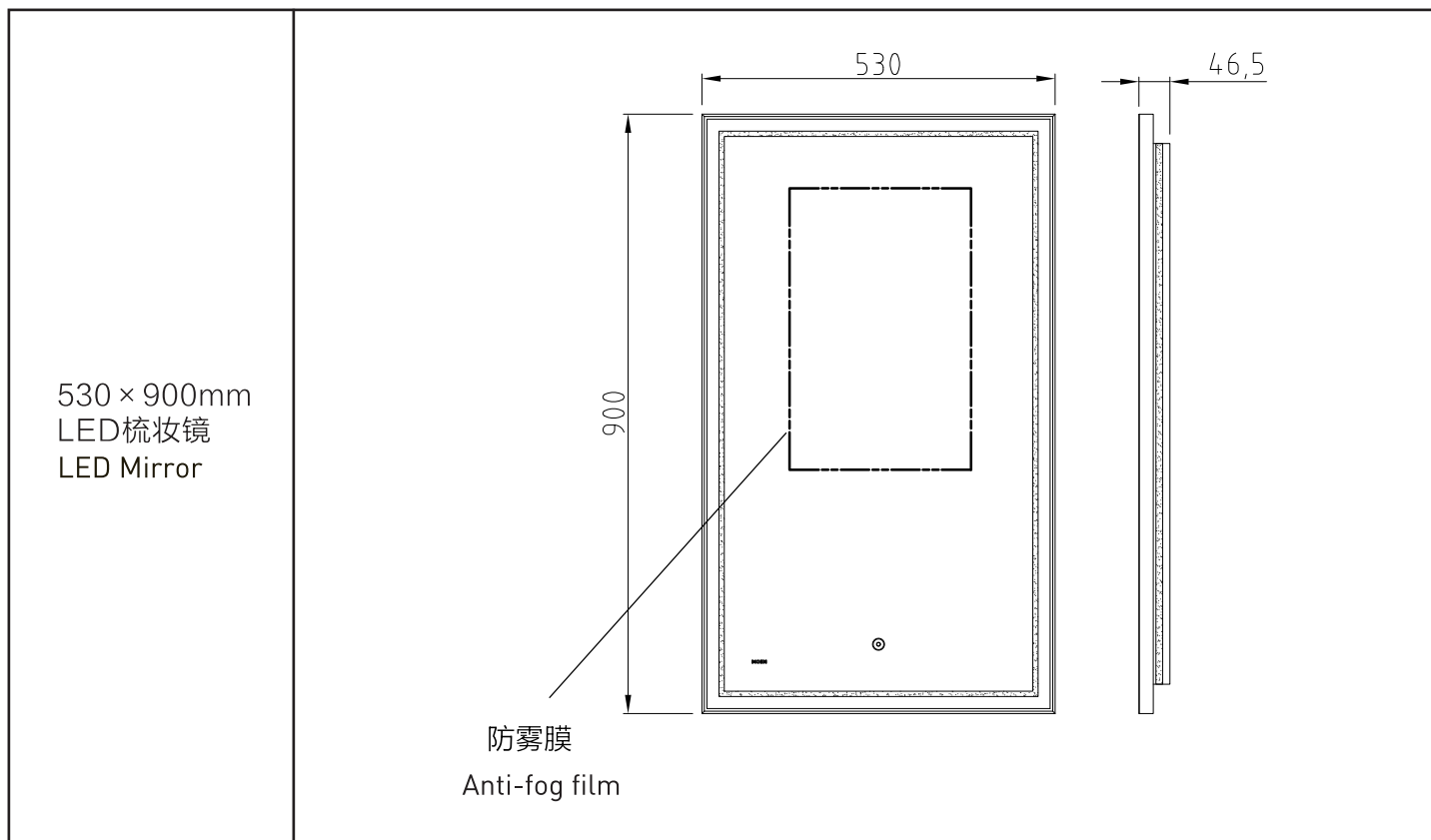

注：摩恩公司保留随时变更图中尺寸的权利，无需另行通知。

Note: MOEN reserves the right to change marked dimensions without prior notice.

电线连接说明

镜子接线：将电源的出线接入220V

Wire Connection Installation

Mirror wire: Connect the outlet wire to power supply in 220V.

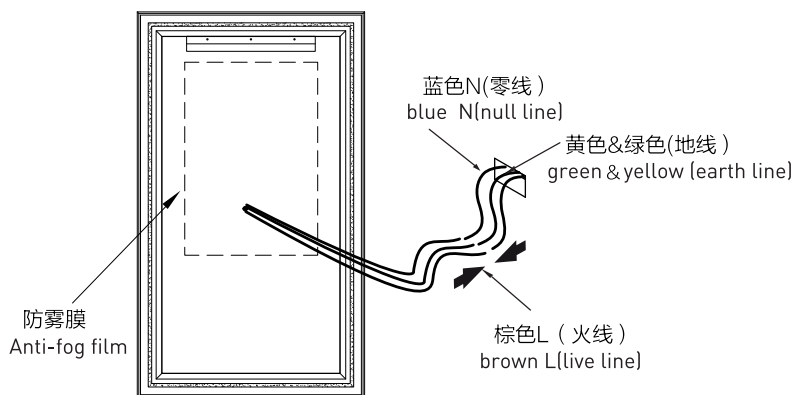

镜子安装说明

1. 按照以下对应孔距，在墙上确定打孔位置；
2. 按照孔位打孔后，装上3个上墙胶粒；
3. 在3个上墙胶粒处，对齐挂板孔，将挂板锁在墙上；
4. 将镜子挂在挂板上，向下轻拉卡紧，固定位置时注意用水平尺调好水平。

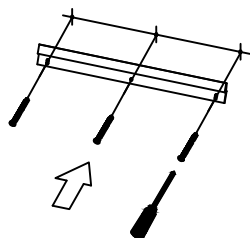

Mirror Installation

1. Determine the punching position on the wall according to the following corresponding hole distances.
2. After punching to the hole position, install 3 plastic particles in wall.
3. Align the holes of the hanging plate at the 3 plastic particles on the wall, and lock the hanging plate into the wall rubber particles.
4. Hang the mirror on the hanging plate and pull it down to tighten. When fixing the position, pay attention to adjust the level with a spirit level.

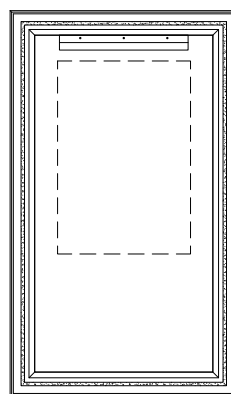

孔中心距 Hole Center Distance

型号 / SKU	产品名称 / Product Name	孔中心距 / Hole Center Distance
BCM21-001BK/WH	1000 × 600mm LED梳妆镜	125mm
BCM21-002BK/WH	530 × 900mm LED梳妆镜	101.5mm

触摸开关使用

- 通电后，点击触摸开关，镜灯点亮同时防雾膜开启，再次点击触摸开关，镜灯熄灭同时防雾膜关闭。
- 镜灯点亮时，长按触摸开关2秒以上实现调光功能，当手指松开，再长按触摸开关，灯光亮度从最亮到最暗，或者是从最暗到最亮。

Touch Switch Usage

- After power on, click the touch switch, the light is on and the anti-fog film is turned on as well; and click the switch again, the light is off and the anti-fog film is turned off as well.
- When the light is on, long press the touch switch for more than 2 seconds to realize the dimming function. When the hand is released, press and hold the touch switch again, the light will change from the brightest to the darkest, or from the darkest to the brightest.

电子部件清单 Electronic Parts List

BCM21-001BK/WH 1000×600mm LED梳妆镜 / LED Mirror

序号 Number	电器功能 Electrical function	规格描述 Specification description	位置 Position
1	梳妆镜电线 Wire	交流电压: 220V 额定电流: 5A AC voltage: 220 V, rated current: 5A	梳妆镜背部 Mirror back
2	LED灯 Led light	输入电压:直流电压12V,功率Pmax: 28.5W LED 3000K/4500K/6000K Input voltage: DC voltage 12V, Power Pmax: 28.5W LED 3000K/4500K/6000K	梳妆镜正面 Mirror front
3	防雾膜 Antifogging film	输入电压:交流电压220V, 功率Pmax: 34.9W Input voltage: AC voltage 220V, Power Pmax: 34.9W	梳妆镜背部 Mirror back
4	触摸控制开关 Touch control switch	防雾膜、LED灯共用触摸开关 Antifogging film and LED lamp share touch switch	梳妆镜正面 Mirror front
5	适配器 Adapter	输入:交流电压200-240V 电流0.25A 输出:直流电压12V 电流3.33A Input: AC voltage 220-240V, current 0.25A Output: DC voltage 12V current 3.33A	梳妆镜背部 Mirror back

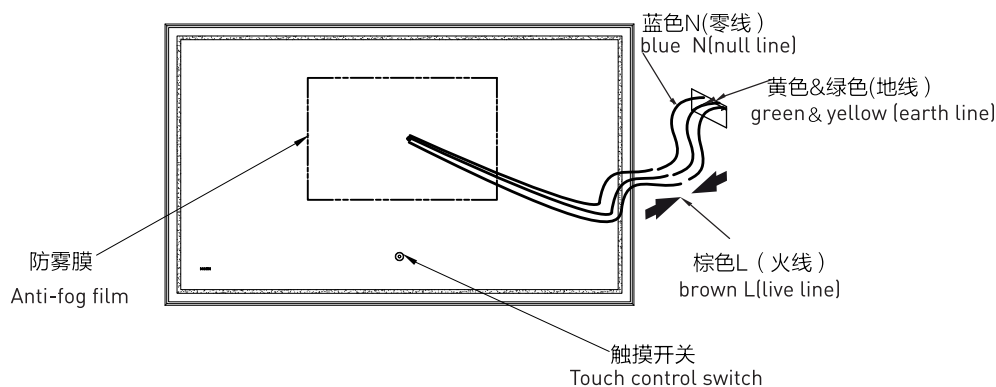

BCM21-002BK/WH 600×800mm LED梳妆镜 / LED Mirror

序号 Number	电器功能 Electrical function	规格描述 Specification description	位置 Position
1	梳妆镜电线 Wire	交流电压: 220V 额定电流: 5A AC voltage: 220 V, rated current: 5A	梳妆镜背部 Mirror back
2	LED灯 Led light	输入电压:直流电压12V,功率Pmax: 25.5W LED 3000K/4500K/6000K Input voltage: DC voltage 12V, Power Pmax: 25.5W LED 3000K/4500K/6000K	梳妆镜正面 Mirror front
3	防雾膜 Antifogging film	输入电压:交流电压220V, 功率Pmax: 34.9W Input voltage: AC voltage 220V, Power Pmax: 34.9W	梳妆镜背部 Mirror back
4	触摸控制开关 Touch control switch	防雾膜、LED灯共用触摸开关 Antifogging film and LED lamp share touch switch	梳妆镜正面 Mirror front
5	适配器 Adapter	输入:交流电压200-240V 电流0.2A 输出:直流电压12V 电流2.5A Input: AC voltage 220-240V, current 0.2A Output: DC voltage 12V current 2.5A	梳妆镜背部 Mirror back

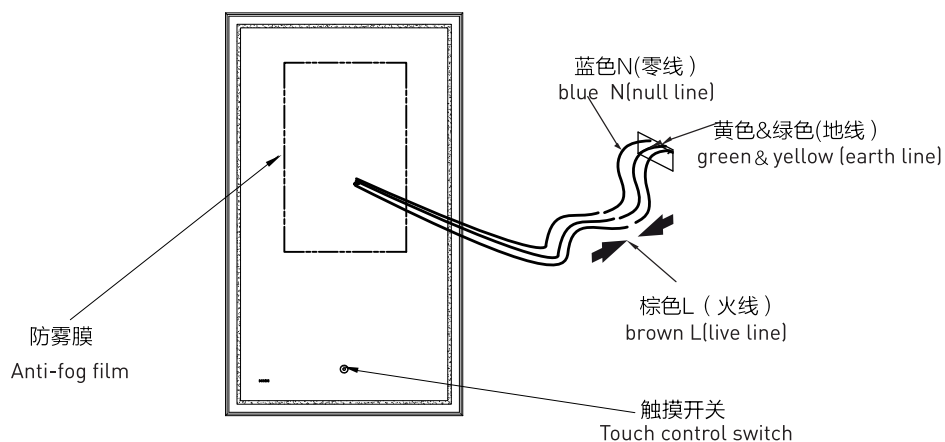

维护保养

使用环境要求

- **干湿分离的卫生间：**淋浴间和其它区域相分隔，淋浴的水不会四处飞溅，是配置浴室镜的最佳环境。
- **非干湿分区的卫生间：**镜子较易被溅水或受潮，其镜子基材可能会发霉膨胀，从而影响使用寿命。
- **日常使用注意事项：**
 - a. 保持卫生间的空气流通及地面的干燥。
 - b. 不允许水溅落到镜子上。如果不小心沾上水，要及时用干抹布擦干，保持镜子干爽洁净。

日常清洁与保养

- 切勿让儿童爬上镜子或承受重压，以防发生危险或造成损坏。
- 镜子使用时，不可任意被水浇、溅。如有水迹请及时用干抹布擦干。
- 镜子是由玻璃镜和铝材制造出来的，只能用柔软的潮布清洁。清洁时请将水喷在布上，而不是玻璃镜上，含氨或酸的清洁剂会损坏玻璃镜。
- 千万不要用磨砂型清洁剂擦拭镜子任何地方。
- 镜子的保养：用软布定期清洁、擦拭，洗浴后的冷凝蒸汽用干布擦净，保持门板干爽。
- 照明灯等电器要确保绝缘、防潮。

Care and Maintenance

Use Environmental Requirements

- **The toilet is separating dry space from moist space:** The shower room is separated from other areas. It is the best environment for configuring bathroom mirror.
- **The toilet is not separating dry space from moist space:** The mirror is likely to be splashed or damp, and the base material of the mirror may become moldy and swell, which will affect the service life.
- **Daily Usage Considerations:**
 - a. Keep the air circulation in the toilet and dry the floor.
 - b. Do not allow water to splash on the mirror. If you accidentally get water, wipe it with a dry cloth in time to keep the mirror dry and clean.

Cleaning and Maintenance

- Do not allow children to climb on the mirror cabinet or bear heavy pressure to prevent danger or damage.
- Do not splash and pour water directly on the mirror wipe any splashes from surfaces immediately.
- The mirror are constructed of mirror and aluminum.
- Use only soft cloth to clean. Spray the cloth, not the mirror when cleaning. Mirrors are damaged by the use of ammonia or vinegar based cleaners. Use no abrasive cleansers on any part of the mirror.
- Maintenance: Clean and wipe mirror regularly, and wipe the condensation vapor with dry and soft cloth.
- The electrical connection of lighting lamps and other electrical appliances should be insulated and moisture-proof.

产品售后保修条款

摩恩产品是在高质量标准及生产工艺下制造的，摩恩承诺为消费者购买的洁具产品提供有期限免费保修及终身维修服务。

梳妆镜免费保修期为1年，均自消费者购买日（以摩恩产品分销商开具的发票或收据上载明日期为准）起计。

免费保修范围为产品及产品配件由于材质及工艺原因而造成的故障或损坏。免费保修期内，我们将无偿为您提供维修服务及更换发生故障的产品或产品配件。摩恩的售后服务责任仅限于对故障产品的修理，而不延及您因产品故障而发生的其他损失，法律另有规定的除外。

您需了解：产品外观碰伤、刻划痕迹，以及滥用及不正当保养所导致的故障或损坏，均不属于免费保修范围。即使在免费保修期内，属下列（1）-（5）情况之一的，需酌情收取修理费用：

1. 不能出示相符的保修卡和有效购买凭证情况的，
2. 未按使用说明告知的使用方法和注意事项造成的故障，
3. 自行拆卸、维修、改装所造成的故障和损坏，
4. 由于不可抗力等外部原因引起的故障和损坏，
5. 由于运输、搬卸、挤压等造成的损坏。

对于保修期外或不在保修范围内的产品，如需维修，摩恩将酌情收取上门费、人工费及材料费。

本保修条款仅对原始消费者和酒店行业的购买者有效，并不适用于本产品工业，商业，贸易和非酒店行业的使用。

如对本保修条款内容有任何疑问，请拨打400 630 8866 咨询热线，或向当地分销商咨询。

MOEN LIMITED WARRANTY

We offer limited warranty and lifetime maintenance for Moen products, which are all manufactured with high standards of workmanship.

The period of warranty shall start from the date of purchase of the product (according to the invoice or receipt issued by Moen distributors) and shall cover a period of the following: The warranty period for mirror is 1 year.

This warranty is your coverage against material and workmanship malfunction or defects in Moen products or components. During the warranty period, we offer free maintenance and changing of malfunctioned products or product components. Moen's after sales service liability is limited to the maintenance of faulty items and does not cover your other losses caused by product malfunction, except for otherwise stipulated by law.

Cosmetic damages (scratches, dents, etc.) and malfunction or defects caused by abuse or improper maintenance is not covered by this warranty. Although the warranty period remains valid, in case of the following conditions (1) - (5), the maintenance cost (material cost and labor cost) shall still be charged as the case may be:

1. Corresponding warranty card and valid invoice cannot be presented;
2. Faults were caused by the incompliance with the instructions and precautions provided in the user's manual;
3. Damages and faults were caused by self-actuated dismantling, repair and refit;
4. Faults and damages were caused by external factors such as force majeure;
5. Damages were caused by transportation, unloading and extrusion, etc.

This warranty is valid for the original consumers only (including hotel use), and excludes industrial and commercial use of the product (except for hotel use). This card is only responsible for product maintenance rather than any other liabilities.

In the event that the product requires maintenance but exceeds the warranty period, or that the product is not covered by this warranty, labor cost and material cost shall be charged as the case may be.

Please call 400-630-8866 or contact local dealer for any question.

MOEN® 摩恩

合格证 Compliance Certification

产品名称 LED梳妆镜
Product Name LED Mirror

检验员
Inspector

生产日期
Date of Production

富俊汇赢科技（上海）有限公司
中国（上海）自由贸易试验区新杨公路
1800弄1号4幢207室
邮编：201413

Fortune Brands Innovations (Shanghai) Co., Ltd
Room 207, Building 4, No. 1, Lane 1800, Xinyang Highway,
China (Shanghai) Pilot Free Trade Zone